

# **VOLMED**

Serving Healthcare Since 1971



## **GENERAL SURGICAL INSTRUMENTS CATALOG**

[www.volmed.co.uk](http://www.volmed.co.uk)

## About Us

With over 50 years of industry experience, VOLMED is a family-owned company specializing in the supply of high-quality surgical instruments to the medical and surgical markets across the United Kingdom, Europe, and globally. Our extensive expertise enables us to assist with project research and development, ensuring that we meet the evolving needs of our clients.

Our philosophy is simple: we treat our customers as we would like to be treated, which places customer satisfaction at the forefront of our priorities. This approach naturally aligns with our commitment to delivering products of the highest quality. Ultimately, our goal is to empower you to provide the best possible care and achieve improved health outcomes by streamlining the process of stocking your practice.

We take pride in the breadth of our product offerings, understanding that sourcing medical tools and surgical instruments from multiple suppliers can be both time-consuming and challenging. To address this, we strive to be your one-stop shop for all your requirements.

## Our History

Our story began over 50 years ago within a family deeply rooted in the medical instrument manufacturing industry. The foundation of our thriving business was built by a team of highly ambitious professionals with expertise in producing plastic surgery, dental and surgical instruments.

Inspired by the potential for excellence, our founder established VOLMED, a company dedicated to providing outstanding customer service and high-quality products. Since then, our team of dedicated professionals has worked tirelessly to ensure that customers worldwide receive only the finest surgical instruments and related services. We never compromise on quality, continually investing in our team, resources, equipment, and processes. Every detail is meticulously examined to ensure we can adapt to changing demands while maintaining the highest standards of quality.

## Our Promise

At VOLMED, our commitment to excellence is unwavering. We strive to achieve the highest standards in everything we do, working relentlessly to provide exceptional service to our customers and everyone associated with our company. We view it as our responsibility to contribute to a better future for the entire community, and we are dedicated to making this vision a reality.



## **Quality**

Our commitment to quality is reflected in our CE and UKCA-marked instruments, manufactured in accordance with stringent global quality assurance standards, including ISO 9001:2015, ISO 13485:2016, and the Medical Device Directive 93/42/EEC.

## **Our Mission**

We are committed to manufacturing and supplying products that meet the highest standards of strength, accuracy, and reliability. Recognizing the critical role our equipment plays in saving lives and improving health, we take this responsibility seriously. Our mission is to simplify the procurement process by offering a comprehensive range of high-quality surgical products under one roof.

## **Products**

At VOLMED, surgical instruments are at the core of our offerings. We provide a wide range of high-quality surgical products suitable for use in operating rooms, wards, veterinary practices, dentistry, and chiropody. Our instruments are crafted to strict standards using a blend of modern technology and traditional craftsmanship, in full compliance with the Medical Devices Directive 93/42/EEC. Complete traceability is maintained throughout the manufacturing process.

To ensure exceptional product performance and reliability, all our products undergo rigorous engineering analysis and stringent inspection methods. VOLMED instruments are guaranteed for five years against manufacturing defects and are made from premium surgical-grade stainless steel, in accordance with ISO 7153-1:2016 specifications. Explore our product listings and catalogues to discover our comprehensive range of surgical instruments.



Esophagoscopy Tracheotomy

**VOLMED**

**VOLMED**

Serving Healthcare Since 1971

Esophagoscopy  
Tracheotomy

Serving Healthcare Since 1971



**34  
26**

**31,26**

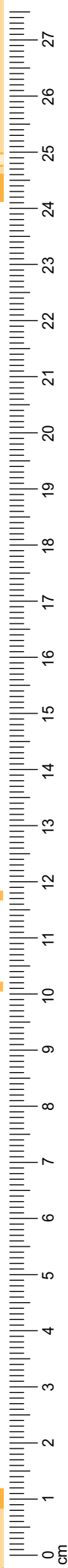





Shaft length

30 cm / 12"	V-034-440	V-034-470	V-034-500	V-034-530	V-034-570	V-034-610	V-034-650
40 cm / 16"	V-034-450	V-034-480	V-034-510	V-034-540	V-034-580	V-034-620	V-034-660
50 cm / 20"	V-034-460	V-034-490	V-034-520	V-034-550	V-034-590	V-034-630	V-034-670
60 cm / 24"	V-034-461	V-034-491	V-034-521	V-034-560	V-034-600	V-034-640	V-034-680

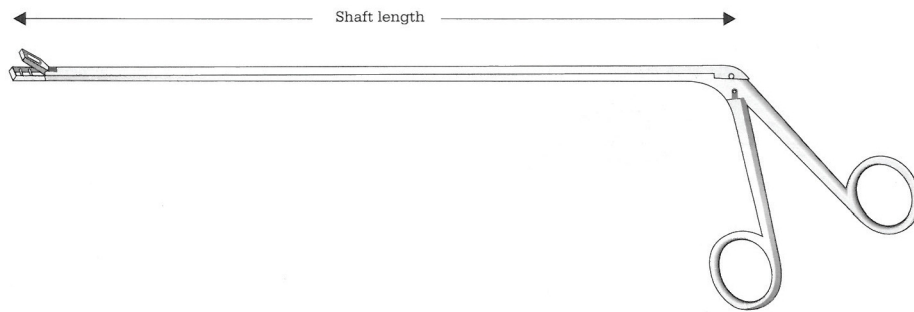

Chevalier-Jackson

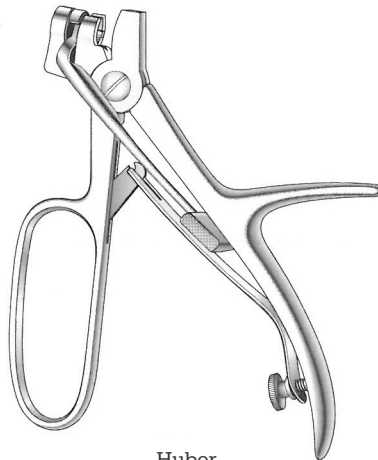

Huber  
V-034-690  
Universal handle



**Bruenings**

V-034-700	20 cm / 8"
V-034-710	30 cm / 12"
V-034-720	40 cm / 16"
V-034-730	50 cm / 20"
V-034-740	60 cm / 24"

Interchangeable tubes

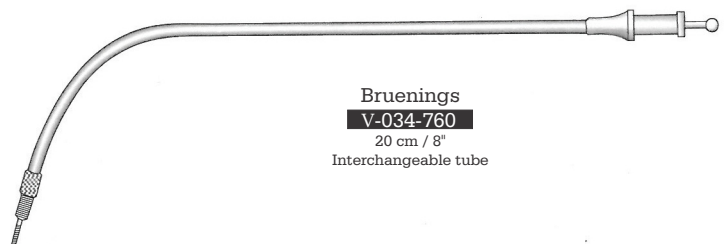

Bruenings  
V-034-760  
20 cm / 8"  
Interchangeable tube

# Esophagoscopy

Exchangeable Tips

Auswechselbare Zangenaufsätze

Pinzas intercambiables



Fraenkel  
V-034-770

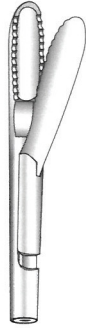

Baracani  
V-034-780

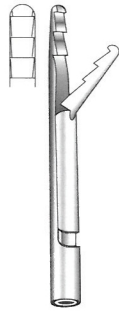

Seiffert  
V-034-790

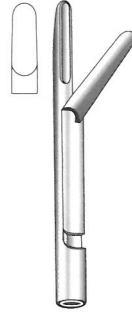

Fraenkel  
V-034-800



Scheinmann  
V-034-810

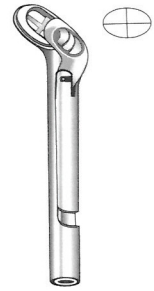

Scheinmann  
V-034-820



V-034-830

V-034-840

Bruenings



V-034-850

V-034-860

Bruenings



Lange  
V-034-870



V-034-880

V-034-890

Krause

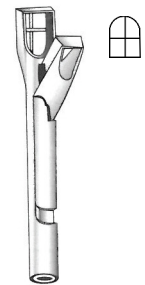

Krause  
V-034-900

V-034-910



V-034-920

V-034-930

V-034-940

Cordes

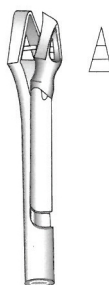

Schumacher  
V-034-950  
With drawing cut



V-034-960

V-034-970

Cordes



Cordes  
V-034-980

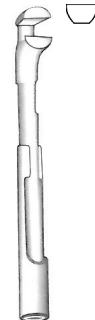

Rosenberg  
V-034-990

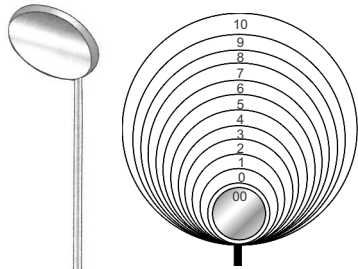

13.5 cm / 5 1/4"  
Plane, without handle

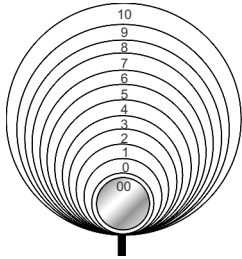

- V-034-1011** Fig. 00 = 8 mm  $\phi$
- V-034-1012** Fig. 0 = 10 mm  $\phi$
- V-034-1013** Fig. 1 = 12 mm  $\phi$
- V-034-1014** Fig. 2 = 14 mm  $\phi$
- V-034-1015** Fig. 3 = 16 mm  $\phi$
- V-034-1016** Fig. 4 = 18 mm  $\phi$
- V-034-1017** Fig. 5 = 20 mm  $\phi$
- V-034-1018** Fig. 6 = 22 mm  $\phi$
- V-034-1019** Fig. 7 = 24 mm  $\phi$
- V-034-1020** Fig. 8 = 26 mm  $\phi$
- V-034-1021** Fig. 9 = 28 mm  $\phi$
- V-034-1022** Fig. 10 = 30 mm  $\phi$

Mirror without handle

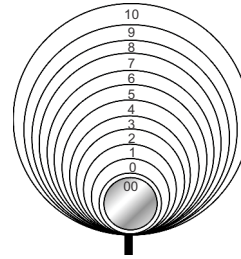

- V-034-1026** Fig. 00 = 8 mm  $\phi$
- V-034-1027** Fig. 0 = 10 mm  $\phi$
- V-034-1028** Fig. 1 = 12 mm  $\phi$
- V-034-1029** Fig. 2 = 14 mm  $\phi$
- V-034-1030** Fig. 3 = 16 mm  $\phi$
- V-034-1031** Fig. 4 = 18 mm  $\phi$
- V-034-1032** Fig. 5 = 20 mm  $\phi$
- V-034-1033** Fig. 6 = 22 mm  $\phi$
- V-034-1034** Fig. 7 = 24 mm  $\phi$
- V-034-1035** Fig. 8 = 26 mm  $\phi$
- V-034-1036** Fig. 9 = 28 mm  $\phi$
- V-034-1037** Fig. 10 = 30 mm  $\phi$

Mirror with handle

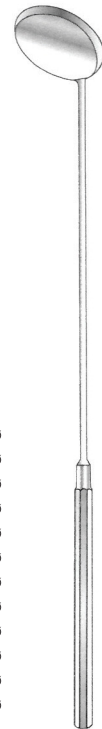

18.5 cm / 7 1/4"  
Plane, with fixed handle  
Rhodium handle

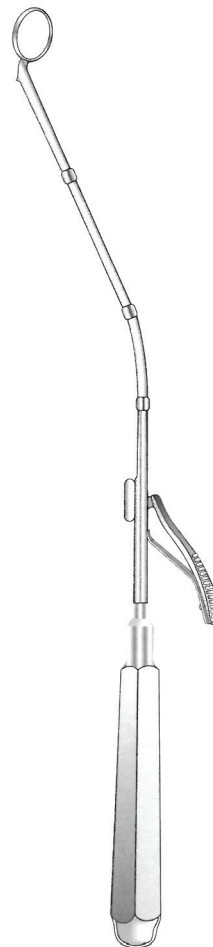

Michel  
25 cm / 10"  
Moveable mirror

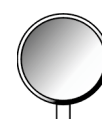

**V-034-1039**  
12 mm  $\phi$   
Fig. 1

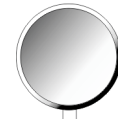

**V-034-1041**  
14 mm  $\phi$   
Fig. 2

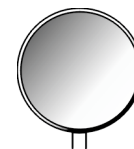

**V-034-1042**  
16 mm  $\phi$   
Fig. 3

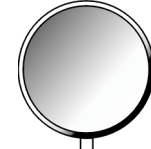

**V-034-1043**  
18 mm  $\phi$   
Fig. 4



**V-034-1024**  
10 cm / 4"

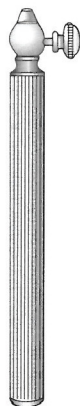

**V-034-1025**  
10 cm / 4"



# Esophagoscopy

Laryngeal Polypus Forceps, Epiglottis Retractor  
 Kehlkopfpolypenzangen, Deckelhalter  
 Pinzas para polipos laringeos, depresor para epiglottis

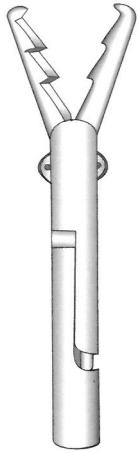

**Kahler**  
**V-034-1260**  
 40 cm / 16"  
 Tip 4 mm

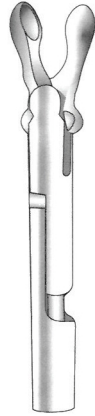

**V-034-1270**  
 30 cm / 12"  
 Tip 7 mm

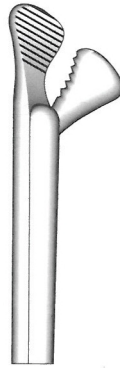

**Papilloma**  
**V-034-1265**  
 30 cm / 12"  
 Tip 7 mm

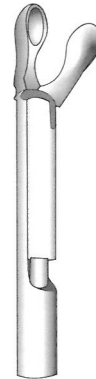

**Jackson**  
**V-034-1275** 30 cm / 12", 2 mm  
 Straight  
**V-034-1276** 30 cm / 12", 4 mm  
 Curved

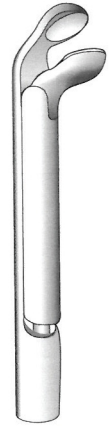

**Jackson**  
**V-034-1280**  
 30 cm / 12", 4 mm  
 Angled

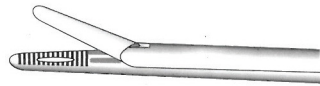
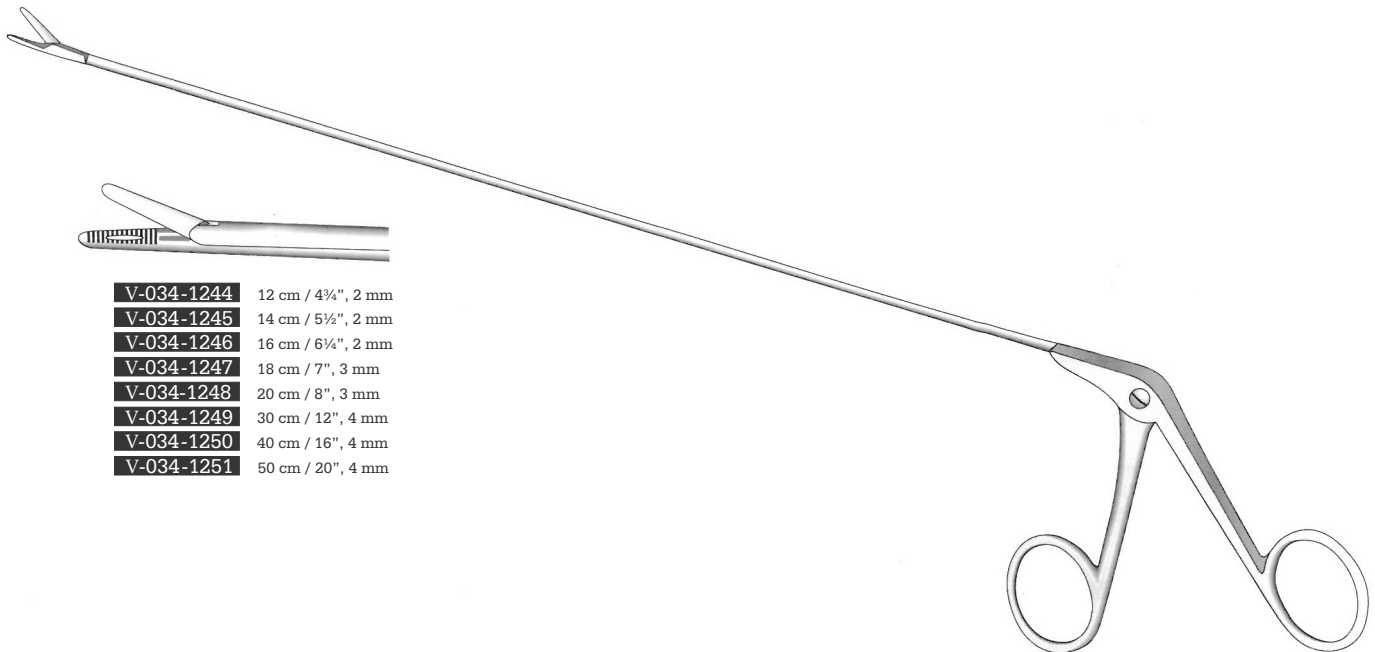

- V-034-1244** 12 cm / 4 1/4", 2 mm
- V-034-1245** 14 cm / 5 1/2", 2 mm
- V-034-1246** 16 cm / 6 1/4", 2 mm
- V-034-1247** 18 cm / 7", 3 mm
- V-034-1248** 20 cm / 8", 3 mm
- V-034-1249** 30 cm / 12", 4 mm
- V-034-1250** 40 cm / 16", 4 mm
- V-034-1251** 50 cm / 20", 4 mm

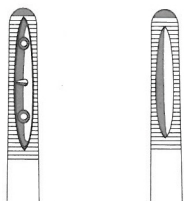

**V-034-1044** 1 x 2 Teeth  
**V-034-1045** Without teeth

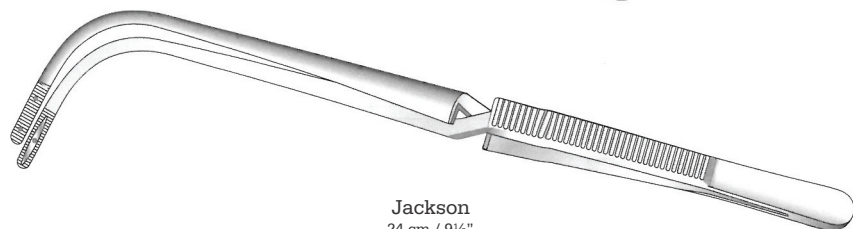

**Jackson**  
 24 cm / 9 1/2"

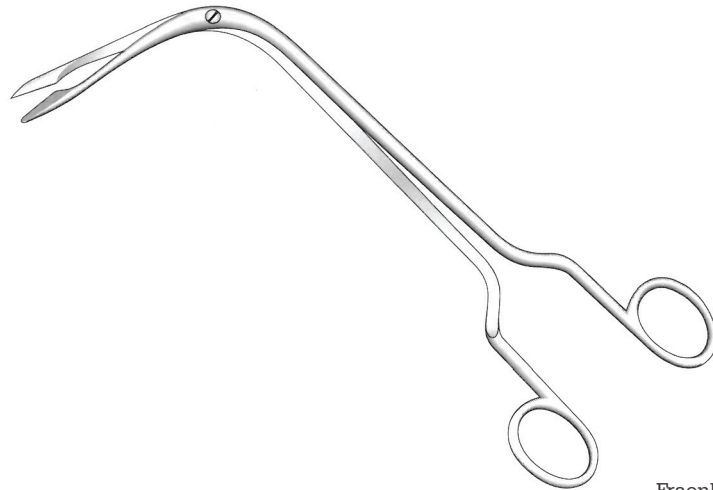
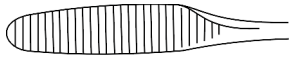

**Fraenkel**  
V-034-1046  
23 cm / 9"

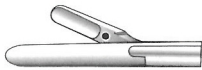

V-034-1047



V-034-1048

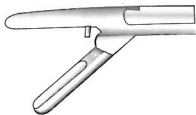

V-034-1049

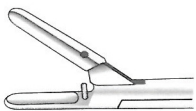

V-034-1051

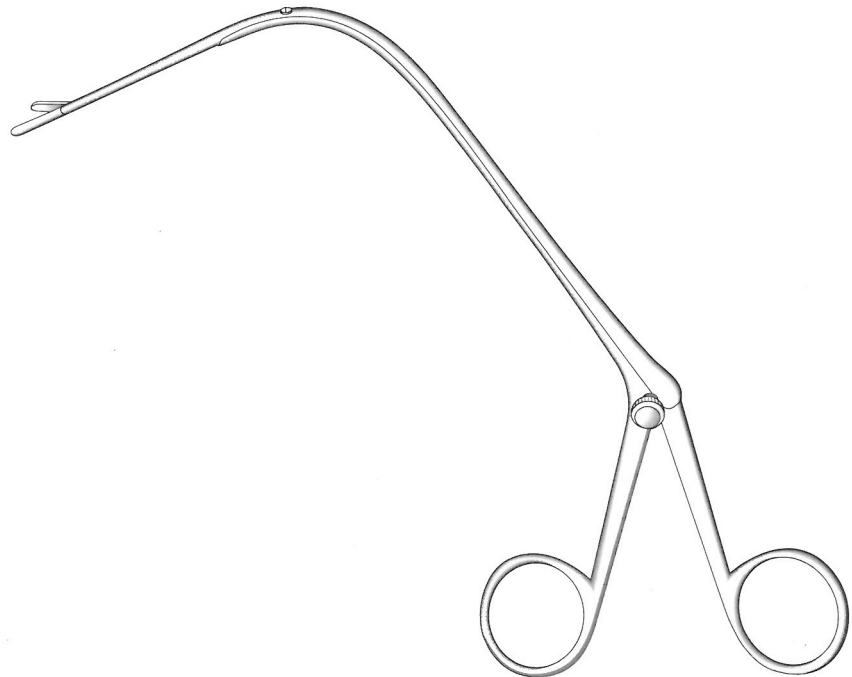

**Jurasz**  
23 cm / 9"

# Tracheotomy

Trachea Trocars and Dilators, Trachea Retractors  
 Tracheal-Trokare und Dilatatoren, Tracheal Hakchen  
 Traquo tomos Y Dilatadores, Separadores prala traquea

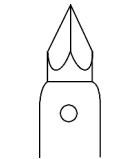
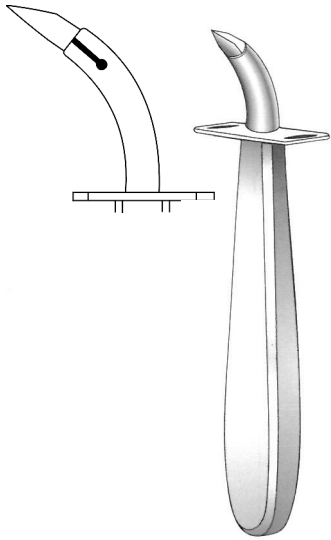

V-026-001  
8 mm

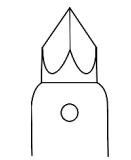

V-026-010  
10 mm

**Uckermann**  
13 cm / 5"  
Hollow handle

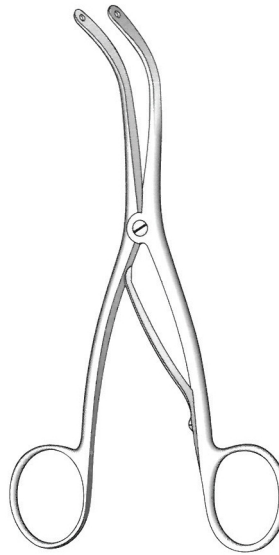

**Trousseau**  
V-026-020  
14 cm / 5½"

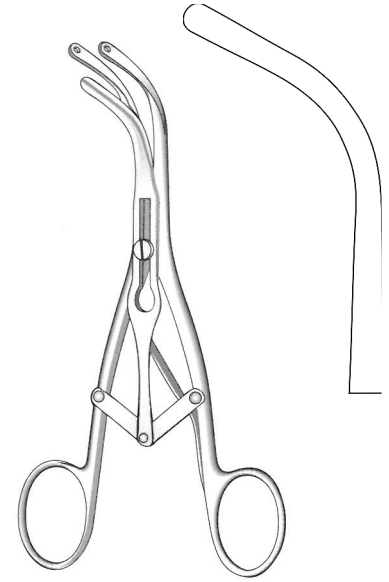

**Laborde**  
V-026-030  
14 cm / 5½"

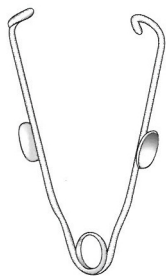

**Bose**  
V-026-040  
7 cm / 2¾"

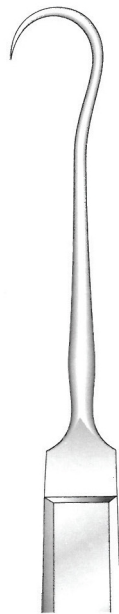

**V-026-050**  
18 cm / 7"

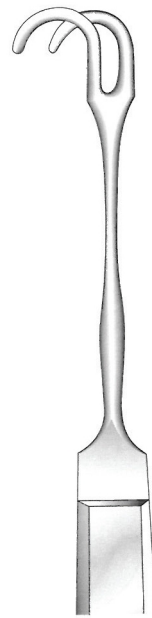

**V-026-060**  
18 cm / 7"



**Iterson**  
16 cm / 6¼"



V-026-070  
Sharp

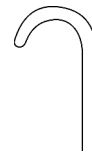

V-026-080  
Blunt



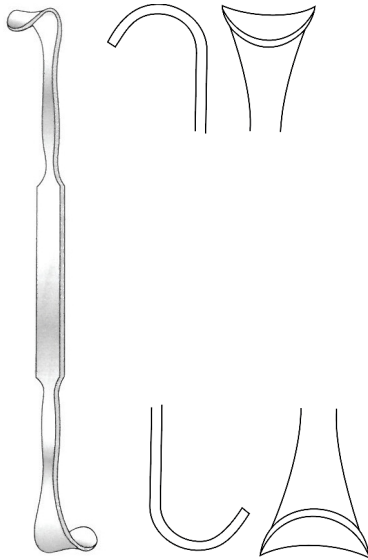

Rose  
V-026-090  
13 cm / 5"

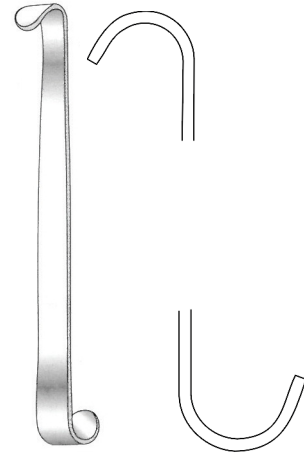

Luer  
V-026-100  
11 cm / 4 1/4"

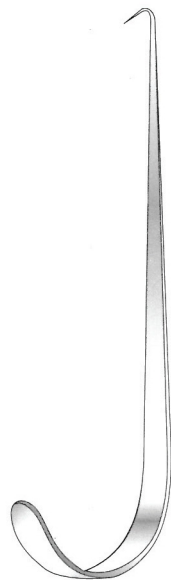

Jackson  
V-026-110  
15 cm / 6"

# Tracheotomy

Tracheal Retractors and Hooks

Tracheal Hakchen und Haken

Seperadores prala traquea Y Ganchos traqueales

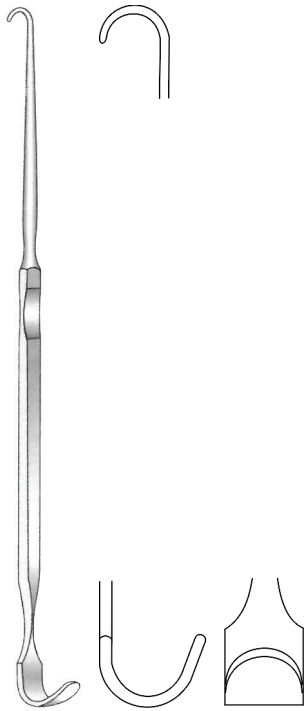

Jackson  
V-026-120  
18 cm / 7"

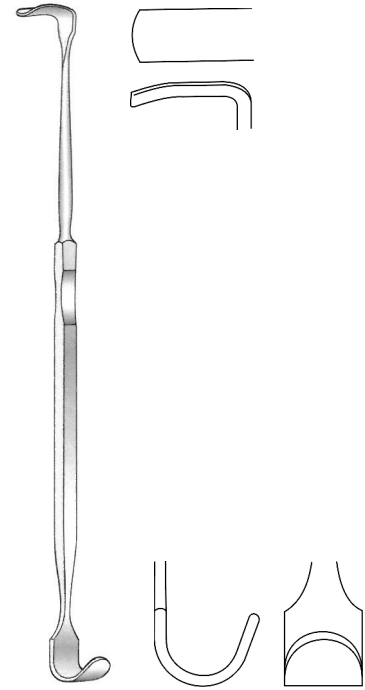



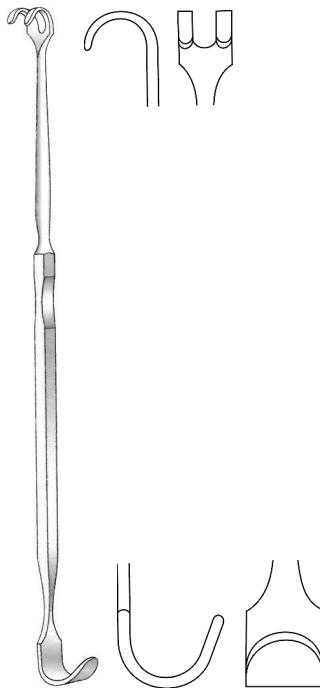







Lukens  
V-026-130  
17 cm / 6 3/4"  
Blunt



Jackson  
V-026-140  
17 cm / 6 3/4"

### International scale

										
Diameter	4 mm $\emptyset$	5 mm $\emptyset$	6 mm $\emptyset$	7 mm $\emptyset$	8 mm $\emptyset$	9 mm $\emptyset$	10 mm $\emptyset$	11 mm $\emptyset$	12 mm $\emptyset$	13 mm $\emptyset$
Length of outer tube	45 mm	50 mm	55 mm	60 mm	65 mm	70 mm	75 mm	80 mm	85 mm	90 mm
	Fig. 0	Fig. 1	Fig. 2	Fig. 3	Fig. 4	Fig. 5	Fig. 6	Fig. 7	Fig. 8	Fig. 9

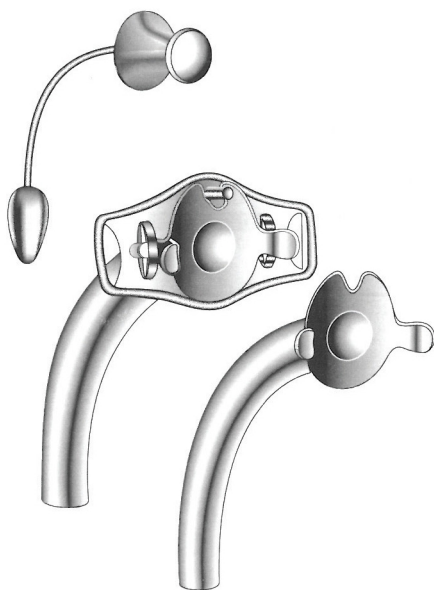

### Chevalier-Jackson

Outer tube closed  
Inner tube closed

Fig.	$\emptyset$
V-026-150	0 4 mm
V-026-160	1 5 mm
V-026-170	2 6 mm
V-026-180	3 7 mm
V-026-190	4 8 mm
V-026-200	5 9 mm
V-026-210	6 10 mm
V-026-220	7 11 mm
V-026-230	8 12 mm
V-026-231	9 13 mm

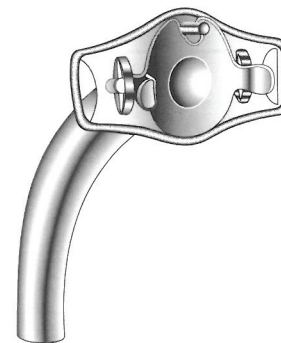

### Luer

Outer tube sieve  
Inner tube sieve

Fig.	$\emptyset$
V-026-240	0 4 mm
V-026-250	1 5 mm
V-026-260	2 6 mm
V-026-270	3 7 mm
V-026-280	4 8 mm
V-026-290	5 9 mm
V-026-300	6 10 mm
V-026-310	7 11 mm
V-026-320	8 12 mm
V-026-321	9 13 mm



International scale

Diameter	4 mm Ø	5 mm Ø	6 mm Ø	7 mm Ø	8 mm Ø	9 mm Ø	10 mm Ø	11 mm Ø	12 mm Ø	13 mm Ø
Length of outer tube	45 mm Fig. 0	50 mm Fig. 1	55 mm Fig. 2	60 mm Fig. 3	65 mm Fig. 4	70 mm Fig. 5	75 mm Fig. 6	80 mm Fig. 7	85 mm Fig. 8	90 mm Fig. 9

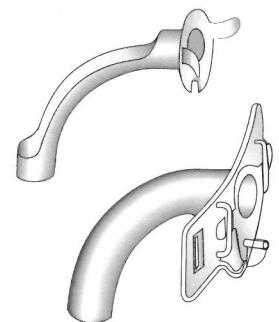
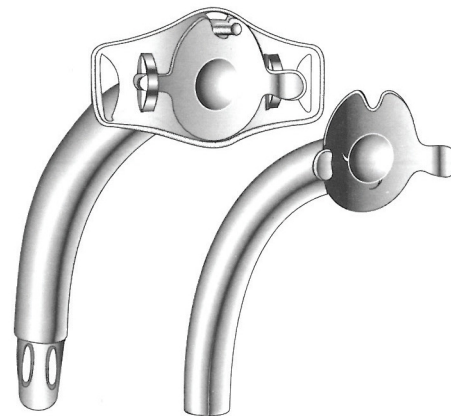
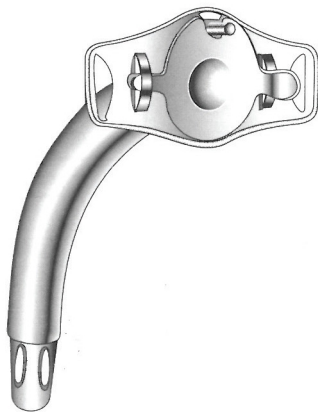

Krishaber

	Fig.	Ø
V-026-330	0	4 mm
V-026-340	1	5 mm
V-026-350	2	6 mm
V-026-360	3	7 mm
V-026-370	4	8 mm
V-026-380	5	9 mm
V-026-390	6	10 mm
V-026-400	7	11 mm
V-026-410	8	12 mm











Krishaber-Luer

	Fig.	Ø
V-026-420	0	4 mm
V-026-430	1	5 mm
V-026-440	2	6 mm
V-026-450	3	7 mm
V-026-460	4	8 mm
V-026-470	5	9 mm
V-026-480	6	10 mm
V-026-490	7	11 mm
V-026-500	8	12 mm

Parker

	Fig.	Ø
V-026-510	1	16 mm
V-026-520	2	18 mm
V-026-530	3	20 mm
V-026-540	4	22 mm
V-026-550	5	24 mm
V-026-560	6	26 mm
V-026-570	7	28 mm
V-026-580	8	30 mm
V-026-590	9	32 mm

International scale

										
Diameter	4 mm Ø	5 mm Ø	6 mm Ø	7 mm Ø	8 mm Ø	9 mm Ø	10 mm Ø	11 mm Ø	12 mm Ø	13 mm Ø
Length of outer tube	45 mm	50 mm	55 mm	60 mm	65 mm	70 mm	75 mm	80 mm	85 mm	90 mm
	Fig. 0	Fig. 1	Fig. 2	Fig. 3	Fig. 4	Fig. 5	Fig. 6	Fig. 7	Fig. 8	Fig. 9



Collin

	Fig.	Ø
V-026-600	0	4 mm
V-026-610	1	5 mm
V-026-620	2	6 mm
V-026-630	3	7 mm
V-026-640	4	8 mm
V-026-650	5	9 mm
V-026-660	6	10 mm
V-026-670	7	11 mm
V-026-680	8	12 mm



Fuller

	Fig.	Ø
V-026-690	1	18 mm
V-026-700	2	20 mm
V-026-710	3	22 mm
V-026-720	4	24 mm
V-026-730	5	26 mm
V-026-740	6	28 mm
V-026-750	7	30 mm
V-026-760	8	32 mm

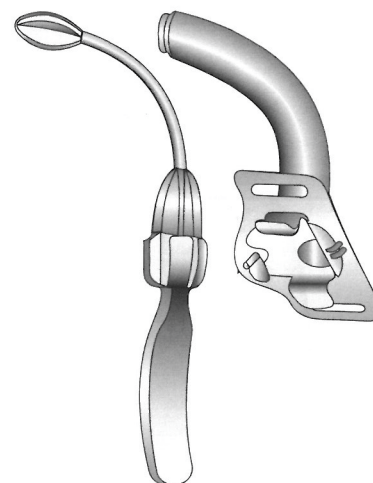

Cubley

	Fig.	Ø
V-026-770	1	16 mm
V-026-780	2	18 mm
V-026-790	3	20 mm
V-026-800	4	22 mm
V-026-810	5	24 mm
V-026-820	6	26 mm
V-026-830	7	28 mm
V-026-840	8	30 mm
V-026-850	9	32 mm



Serving Healthcare Since 1971

## CONTACT US

Creative Industries Centre,  
Glaisher Drive Wolverhampton Science Park,  
Wolverhampton United Kingdom,  
WV10 9TG

**Email queries:**

[info@volmed.co.uk](mailto:info@volmed.co.uk) / [sales@volmed.co.uk](mailto:sales@volmed.co.uk)

[www.volmed.co.uk](http://www.volmed.co.uk)